

SPECIFICATIONS

8mm fixed panel with 6mm door

Any width required

Angled doors

4 week delivery

Easy ordering



DESIGN RANGE BESPOKE SHOWER ENCLOSURES

Design View is not available as a bespoke option.

Simpsons Design Range Bespoke Service provides you with the opportunity to achieve that minimalist contemporary look in even the most awkward spaces. Angle cuts and different height and width combinations offer endless possibilities for that unusual shaped space.

Manufactured to exacting standards by our own specialist machinists, this bespoke service is often the best solution.

Door and Inline panel

Special Height - Current height of 1950mm can be reduced to any height.

Special Width - Minimum width of door and inline panel is 700mm combined.

Stock Door Widths - Door widths cannot be changed from current stock widths.
Door widths available: 450, 510, 550, 600, 650.

Restrictions - Height of door and inline panel cannot be increased above 1950mm.
Minimum width of inline panel is 150mm.

Angle Cut - Angle cut cannot be made to the hinge side of the enclosure. Angle cut to door and inline panel cannot extend beyond 50% of the width of the inline panel due to the bracing bar.

RRP Plus - 40%

Side Panel

Special Height - Current height of 1950mm can be reduced to any height.

Special Width - Side panel can be made to any width up to a maximum of 1400mm.

Restrictions - Minimum width of a panel is 150mm.

Angle Cut - Angle cut cannot be made to wall side due to the bracing bar.

RRP Plus - 40%

Walk In Panel

Special Width - Walk in front panel can be made to any width to a maximum of 1400mm.

RRP Plus - 40%

Walk In Return Panel

Restrictions - No adjustments possible due to design of glass/tray combination.

BESPOKE ENCLOSURES

Design range

DESIGN RANGE

FAX BACK ORDER FORM

0845 873 8841



Please complete this form and return it to your retailer who will then fax it to Simpsons to confirm receipt and acceptance of the order.

Retailer Details

Order ref

Company Name

Address

Postcode

Tel

Fax

Email

Customer Details

Name

Address

Postcode

Tel

Fax

Email

Product Details

Description (refer to product pages)

Frame Colour - Supplied with Silver frame

Diagram No. (see overleaf) ()

Glass Colour required (tick appropriate box) Clear () Bronze () Grey () Green ()

Any other relevant info

ClearShield (tick box) ()

Signed (Retailer)

Signed (Customer)

Date

Date

To ensure no delays occur please complete all relevant information and dimensions (mm)

All Bespoke products are non - refundable therefore please ensure that all measurements given are from a finished tile to tile area.

For corner / three - sided situations, give dimensions of the perimeter of the shower enclosure - NOT TRAY SIZE.

Once the order has been placed you will be liable for any charges should you wish to alter or cancel your order.

DESIGN RANGE

FAX BACK ORDER FORM

0845 873 8841



Design View is not available as a bespoke option.

Retailer Details

Order Ref

Diagram 1 - Standard Side Panel

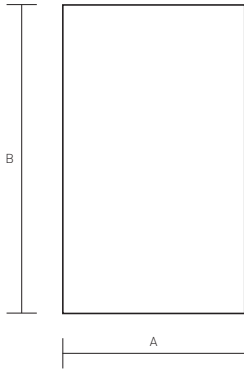

Diagram 2 - Angled Side (Reversible)

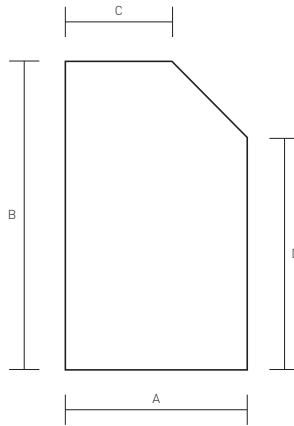

Diagram 3 - Standard Walk In End Panel

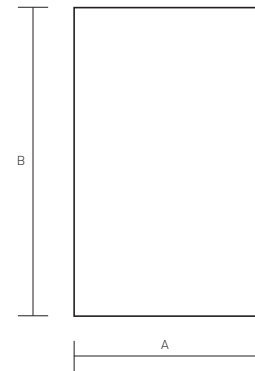

Diagram 4 - Angled Walk In (Reversible)

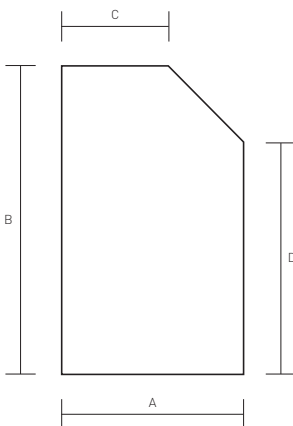

Diagram 5 - Full Angled Walk In (Reversible)
Only for sizes up to 700mm

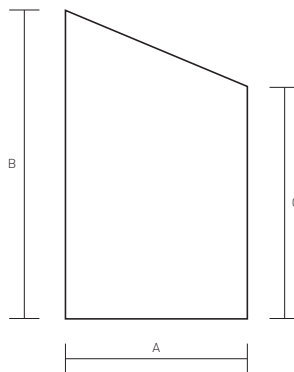

Diagram 6 - Standard Inline and Door

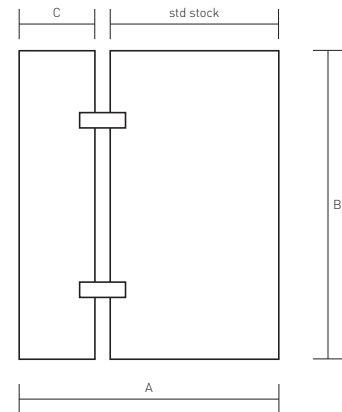

Diagram 7 - Standard Inline and Angle Door (Reversible)

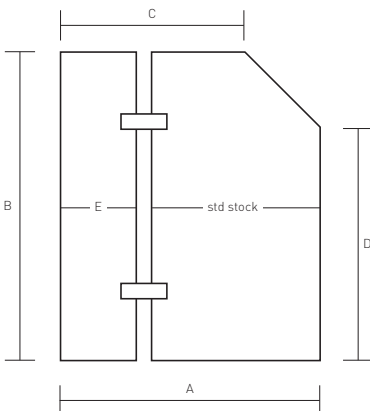
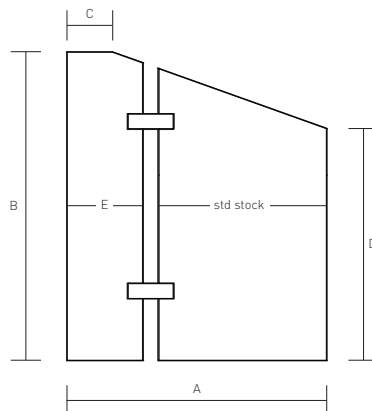

Diagram 8 - Angle Inline and Door (Reversible)



Stock Door Widths (std stock)

Door widths cannot be changed from current stock widths. Door widths available: 450, 510, 550, 600, 650.

Please state chosen size where applicable.

Largest panel width 1400mm.

Required dimensions are as follows: Dimension A - actual aperture width Dimension B - actual finished door height

Item	Diagram No. ()	A ()	B ()	C ()	D ()	E ()	std stock ()
Item 1	Diagram No. ()	A ()	B ()	C ()	D ()	E ()	std stock ()
Item 2	Diagram No. ()	A ()	B ()	C ()	D ()	E ()	std stock ()
Item 3	Diagram No. ()	A ()	B ()	C ()	D ()	E ()	std stock ()



SPECIFICATIONS

Toughened glass*

Any height or width required

Angled doors**

4 week delivery

3 glass colour options***

2 frame colours****

Easy ordering

CLASSIC/SUPREME BESPOKE SHOWER ENCLOSURES

Simpsons Bespoke Service is available for both Classic and Supreme ranges.

Our enviable reputation for quality and service makes us the first choice for all customised shower enclosures.

Your retailer will be able to advise as to whether your plans or ideas are practical and achievable. Your retailer will also help you fill in the order form attached.

Classic

Doors and Panels	Special Height and/or Special Width	RRP Plus 40%
Bath screens	Special Height and/or Special Width	RRP Plus 40%

Coloured Glass Options (Classic and Classic Mode only)

Doors and Panels	Any door or side panel under 2 metres	RRP Plus 20%
------------------	---------------------------------------	---------------------

Supreme

Doors and Panels	Special Height and/or Special Width	RRP Plus 40%
Bath screens	Special Width only	RRP Plus 40%
Bath Guard	Special Height and/or Special Width	RRP Plus 40%

Oversize

Doors and Panels	Any door or side panel over 2 metres	RRP Plus 60%
------------------	--------------------------------------	---------------------



See page 108



See page 132

We cannot accept cancellations of special orders

*4mm Supreme / 6mm Luxury Pivot / 8mm Classic and Classic Mode

**Classic Mode only

***Classic / Classic Mode, specific products only

****Supreme only

Prices are inclusive of VAT.

BESPOKE ENCLOSURES

Classic and Supreme ranges

CLASSIC/SUPREME FAX BACK ORDER FORM 0845 873 8841



Please complete this form and return it to your retailer who will then fax it to Simpsons to confirm receipt and acceptance of the order.

Retailer Details

Order ref

Company Name

Address

Postcode

Tel

Fax

Email

Customer Details

Name

Address

Postcode

Tel

Fax

Email

Product Details (Please note that all corner angles are available in Classic Mode ONLY)

Description (refer to product pages)

Frame Colour required (tick appropriate box) Silver () White - Supreme only ()

Diagram No. (see overleaf) ()

Glass Colour required (tick appropriate box) Clear () Bronze () Grey () Green ()

Any other relevant info

ClearShield (tick box) ()

Signed (Retailer)

Signed (Customer)

Date

Date

To ensure no delays occur please complete all relevant information and dimensions (mm)

All Bespoke products are non - refundable therefore please ensure that all measurements given are from a finished tile to tile area.

For corner / three - sided situations, give dimensions of the perimeter of the shower enclosure - NOT TRAY SIZE.

Once the order has been placed you will be liable for any charges should you wish to alter or cancel your order.



CLASSIC/SUPREME FAX BACK ORDER FORM 0845 873 8841



Retailer Details

Order Ref

Diagram 1 - Height or Width Variation only

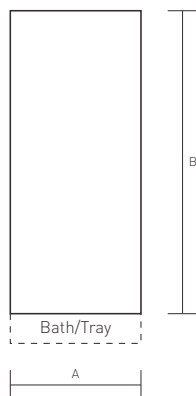

Diagram 2 - Corner Angle (Left handed)*

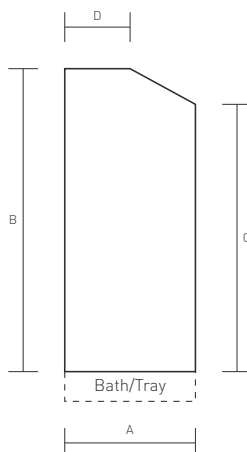

Diagram 3 - Corner Angle (Right handed)

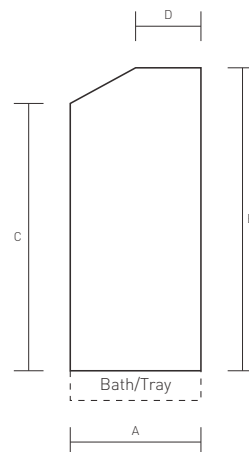

Diagram 4 - Complete Angle (Left handed)*

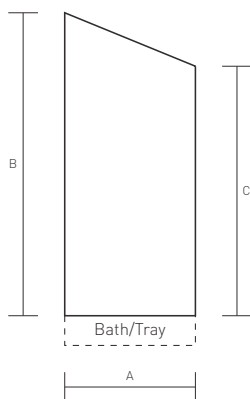

Diagram 5 - Complete Angle (Right handed)*

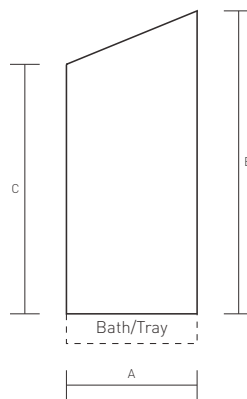

Diagram 6 - Corner Angle with Inline Panel*
(Left handed)

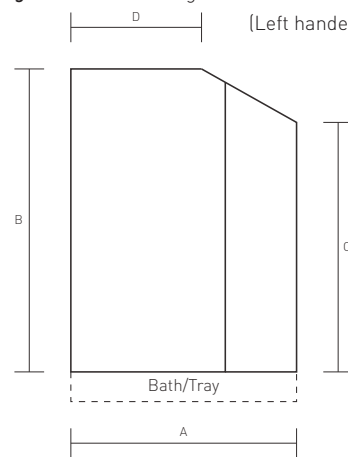

Diagram 7 - Corner Angle with Inline Panel*
(Right handed)

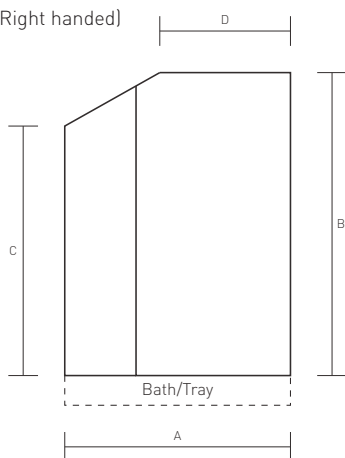

Diagram 8 - Corner Angle with Inline Panel*
(Left handed)

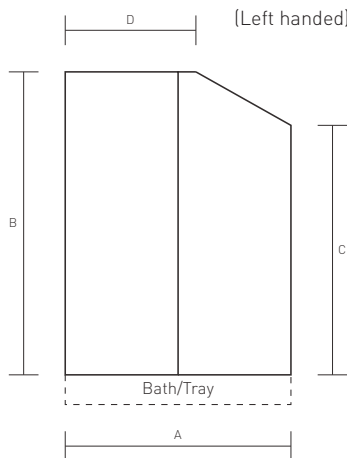
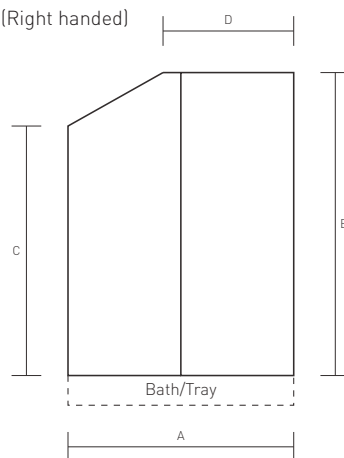

Diagram 9 - Corner Angle with Inline Panel*
(Right handed)



Required dimensions are as follows: Dimension A - actual aperture width Dimension B - actual finished door height

Item	Diagram No. ()	Dimension A ()	Dimension B ()	Dimension C ()	Dimension D ()
Item 1	Diagram No. ()	Dimension A ()	Dimension B ()	Dimension C ()	Dimension D ()
Item 2	Diagram No. ()	Dimension A ()	Dimension B ()	Dimension C ()	Dimension D ()
Item 3	Diagram No. ()	Dimension A ()	Dimension B ()	Dimension C ()	Dimension D ()

* Classic Mode only

